









				<table border="1"> <tr> <td>① 706029</td> <td>PCS</td> <td>② 705041</td> <td>PCS</td> </tr> <tr> <td></td> <td>1</td> <td></td> <td>1</td> </tr> <tr> <td></td> <td></td> <td>19x451x1240</td> <td></td> </tr> <tr> <td>③ 705048</td> <td>PCS</td> <td>④ 705063</td> <td>PCS</td> </tr> <tr> <td></td> <td>2</td> <td></td> <td>3</td> </tr> <tr> <td>120x120</td> <td></td> <td>19x951x1240</td> <td></td> </tr> <tr> <td>⑤ 705350</td> <td>PCS</td> <td>⑥ 902234</td> <td>PCS</td> </tr> <tr> <td></td> <td>2</td> <td></td> <td>2</td> </tr> <tr> <td>120x120x3990</td> <td></td> <td>M12</td> <td></td> </tr> <tr> <td>⑦ 980109</td> <td>PCS</td> <td>⑧ 905051</td> <td>PCS</td> </tr> <tr> <td></td> <td>6</td> <td></td> <td>4</td> </tr> <tr> <td>Ø4x30</td> <td></td> <td>Ø24/8.4</td> <td></td> </tr> <tr> <td>⑨ 905083</td> <td>PCS</td> <td>⑩ 905104</td> <td>PCS</td> </tr> <tr> <td></td> <td>2</td> <td></td> <td>16</td> </tr> <tr> <td>Ø32</td> <td></td> <td>M10</td> <td></td> </tr> <tr> <td>⑪ 704881</td> <td>PCS</td> <td>⑫ 905112</td> <td>PCS</td> </tr> <tr> <td></td> <td>1</td> <td></td> <td>2</td> </tr> <tr> <td>DON'T CLIMB</td> <td></td> <td>Ø22</td> <td></td> </tr> <tr> <td>90x50</td> <td></td> <td>120x120x700</td> <td></td> </tr> <tr> <td>⑬ 905761</td> <td>PCS</td> <td>⑭ 909102</td> <td>PCS</td> </tr> <tr> <td></td> <td>4</td> <td></td> <td>2</td> </tr> <tr> <td></td> <td></td> <td>M12x200</td> <td></td> </tr> <tr> <td></td> <td></td> <td>M8x75</td> <td></td> </tr> <tr> <td>⑮ 905830</td> <td>PCS</td> <td>⑯ 909203</td> <td>PCS</td> </tr> <tr> <td></td> <td>2</td> <td></td> <td>1</td> </tr> <tr> <td>123x123x40</td> <td></td> <td>M8x75</td> <td></td> </tr> <tr> <td>⑰ 906021</td> <td>PCS</td> <td>⑱ 909253</td> <td>PCS</td> </tr> <tr> <td></td> <td>2</td> <td></td> <td>2</td> </tr> <tr> <td>Ø42,4x1252</td> <td></td> <td>Ø32/13.5/2</td> <td></td> </tr> <tr> <td>⑲ 907538</td> <td>PCS</td> <td>⑳ 909506</td> <td>PCS</td> </tr> <tr> <td></td> <td>1</td> <td></td> <td>4</td> </tr> <tr> <td>Ø42,4x1252</td> <td></td> <td>Ø3.5x13</td> <td></td> </tr> <tr> <td>⑳ 906117</td> <td>PCS</td> <td>㉑ 909633</td> <td>PCS</td> </tr> <tr> <td></td> <td>6</td> <td></td> <td>38</td> </tr> <tr> <td>130x44x52</td> <td></td> <td>M8</td> <td></td> </tr> <tr> <td>㉑ 909102</td> <td>PCS</td> <td>㉒ 909852</td> <td>PCS</td> </tr> <tr> <td></td> <td>2</td> <td></td> <td>38</td> </tr> <tr> <td>M12x200</td> <td></td> <td>M8x30</td> <td></td> </tr> <tr> <td>㉒ 909203</td> <td>PCS</td> <td>㉓ 980104</td> <td>PCS</td> </tr> <tr> <td></td> <td>1</td> <td></td> <td>2</td> </tr> <tr> <td>M8x75</td> <td></td> <td>Ø5x90</td> <td></td> </tr> </table>		① 706029	PCS	② 705041	PCS		1		1			19x451x1240		③ 705048	PCS	④ 705063	PCS		2		3	120x120		19x951x1240		⑤ 705350	PCS	⑥ 902234	PCS		2		2	120x120x3990		M12		⑦ 980109	PCS	⑧ 905051	PCS		6		4	Ø4x30		Ø24/8.4		⑨ 905083	PCS	⑩ 905104	PCS		2		16	Ø32		M10		⑪ 704881	PCS	⑫ 905112	PCS		1		2	DON'T CLIMB		Ø22		90x50		120x120x700		⑬ 905761	PCS	⑭ 909102	PCS		4		2			M12x200				M8x75		⑮ 905830	PCS	⑯ 909203	PCS		2		1	123x123x40		M8x75		⑰ 906021	PCS	⑱ 909253	PCS		2		2	Ø42,4x1252		Ø32/13.5/2		⑲ 907538	PCS	⑳ 909506	PCS		1		4	Ø42,4x1252		Ø3.5x13		⑳ 906117	PCS	㉑ 909633	PCS		6		38	130x44x52		M8		㉑ 909102	PCS	㉒ 909852	PCS		2		38	M12x200		M8x30		㉒ 909203	PCS	㉓ 980104	PCS		1		2	M8x75		Ø5x90	
① 706029	PCS	② 705041	PCS																																																																																																																																																																						
	1		1																																																																																																																																																																						
		19x451x1240																																																																																																																																																																							
③ 705048	PCS	④ 705063	PCS																																																																																																																																																																						
	2		3																																																																																																																																																																						
120x120		19x951x1240																																																																																																																																																																							
⑤ 705350	PCS	⑥ 902234	PCS																																																																																																																																																																						
	2		2																																																																																																																																																																						
120x120x3990		M12																																																																																																																																																																							
⑦ 980109	PCS	⑧ 905051	PCS																																																																																																																																																																						
	6		4																																																																																																																																																																						
Ø4x30		Ø24/8.4																																																																																																																																																																							
⑨ 905083	PCS	⑩ 905104	PCS																																																																																																																																																																						
	2		16																																																																																																																																																																						
Ø32		M10																																																																																																																																																																							
⑪ 704881	PCS	⑫ 905112	PCS																																																																																																																																																																						
	1		2																																																																																																																																																																						
DON'T CLIMB		Ø22																																																																																																																																																																							
90x50		120x120x700																																																																																																																																																																							
⑬ 905761	PCS	⑭ 909102	PCS																																																																																																																																																																						
	4		2																																																																																																																																																																						
		M12x200																																																																																																																																																																							
		M8x75																																																																																																																																																																							
⑮ 905830	PCS	⑯ 909203	PCS																																																																																																																																																																						
	2		1																																																																																																																																																																						
123x123x40		M8x75																																																																																																																																																																							
⑰ 906021	PCS	⑱ 909253	PCS																																																																																																																																																																						
	2		2																																																																																																																																																																						
Ø42,4x1252		Ø32/13.5/2																																																																																																																																																																							
⑲ 907538	PCS	⑳ 909506	PCS																																																																																																																																																																						
	1		4																																																																																																																																																																						
Ø42,4x1252		Ø3.5x13																																																																																																																																																																							
⑳ 906117	PCS	㉑ 909633	PCS																																																																																																																																																																						
	6		38																																																																																																																																																																						
130x44x52		M8																																																																																																																																																																							
㉑ 909102	PCS	㉒ 909852	PCS																																																																																																																																																																						
	2		38																																																																																																																																																																						
M12x200		M8x30																																																																																																																																																																							
㉒ 909203	PCS	㉓ 980104	PCS																																																																																																																																																																						
	1		2																																																																																																																																																																						
M8x75		Ø5x90																																																																																																																																																																							
⑭ 905830	PCS	⑮ 906021	PCS	⑯ 907538	PCS	⑰ 906117	PCS	⑱ 909102	PCS	⑲ 909203	PCS																																																																																																																																																														
	2		2		1		6		2		1																																																																																																																																																														
123x123x40		Ø42,4x1252		Ø42,4x1252		130x44x52		M12x200		M8x75																																																																																																																																																															
⑳ 909233	PCS	㉑ 909253	PCS	㉒ 909506	PCS	㉓ 909633	PCS	㉔ 909852	PCS	㉕ 980104	PCS																																																																																																																																																														
	4		2		4		38		38		2																																																																																																																																																														
8x100		Ø32/13.5/2		Ø3.5x13		M8		M8x30		Ø5x90																																																																																																																																																															

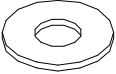

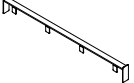
<p>②⑥ 980123</p>  <p>Ø7x60</p>	<p>PCS 68</p>	<p>②⑦ 980150</p>  <p>M8</p>	<p>PCS 1</p>	<p>②⑧ 980151</p>  <p>Ø16/8.4</p>	<p>PCS 2</p>	<p>②⑨ 980152</p>  <p>Ø24/8.4x2</p>	<p>PCS 38</p>	<p>③⑩ 906751</p> 	<p>PCS 1</p>	<p>③① 906009</p>  <p>Ø42,4x1252</p>	<p>PCS 2</p>
<p>③② 909256</p>  <p>Ø16/8.4</p>	<p>PCS 68</p>										



1: 49

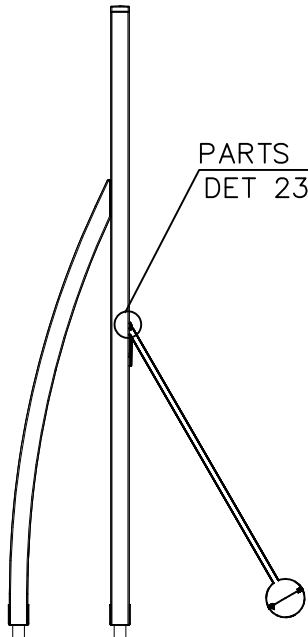

1: 53

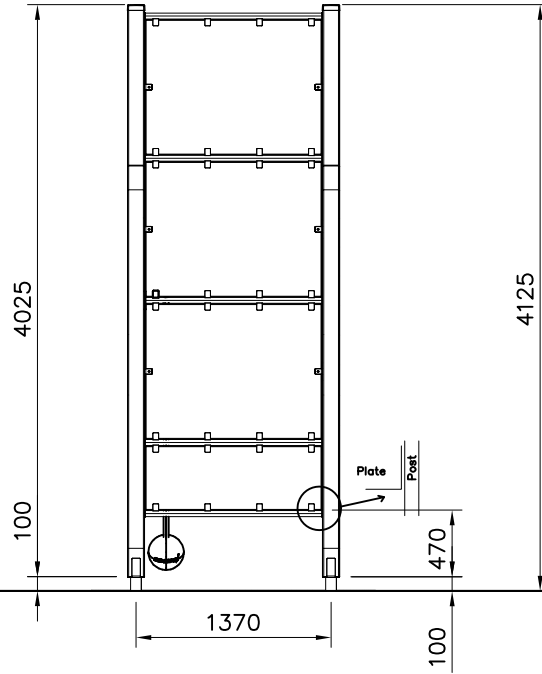

Area of Movement 15 m2  
Training Space 3.1 m2  
Max Falling Height 0 mm

1: 55

