

LAPPSET®

FINNO







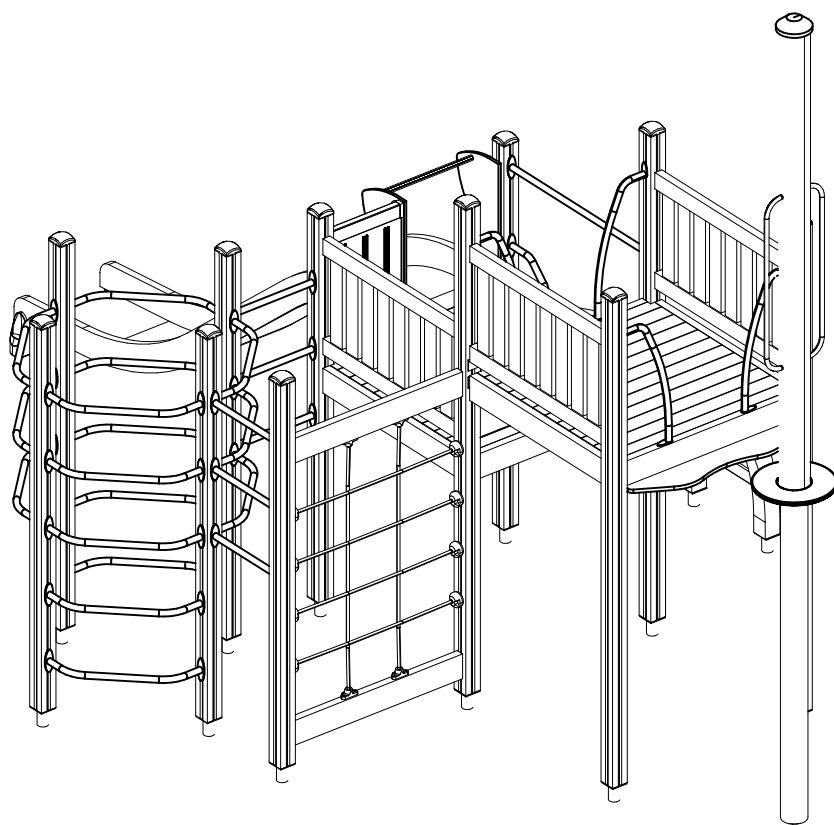



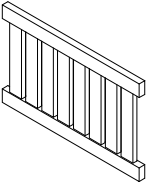

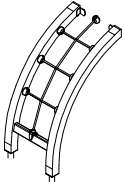





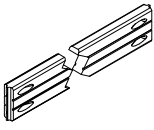

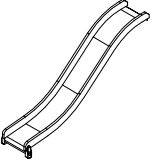



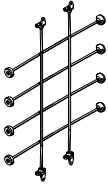

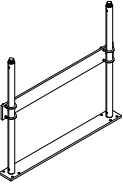





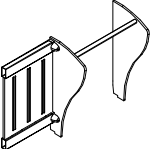

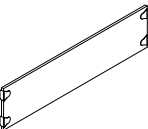





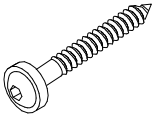



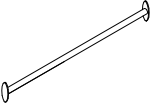

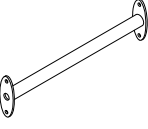



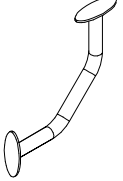

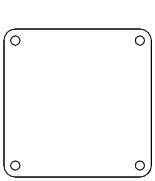

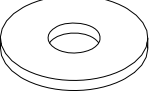

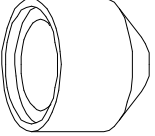

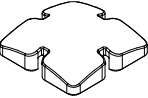

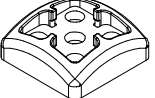
ASENNUSOHJE
MONTERINGSANSVISNING
INSTALLATION INSTRUCTION
AUFBAUANLEITUNG
NOTICE D'INSTALLATION

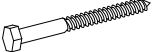
DATE: 8.4.2013

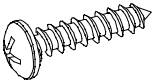
120610M

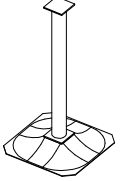

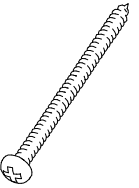
DATE: 8.4.2013

003786  RED 	PCS 3	701105  	PCS 1	701428  L 2250 	PCS 7	701434  L 2850 	PCS 4	701482  L 1104 	PCS 10	701555  	PCS 1
701557  	PCS 2	701623  	PCS 1	701928  	PCS 1	702286  90x50 	PCS 1	702339  90x50 	PCS 1	702572  	PCS 1
702944  	PCS 1	703703  	PCS 1	703755  	PCS 1	900240  8x70 	PCS 108	901782  L 1104 	PCS 4	901785  L 1104 	PCS 1
901790  L 505 	PCS 6	901792  	PCS 16	901798  	PCS 2	902487  65x65 	PCS 2	905051  Ø24/8.4 	PCS 40	905104  M10 	PCS 52
905138  GRAY 	PCS 11	905196  GRAY 	PCS 11	909238  8x90 	PCS 40	909506  Ø3.5x13 	PCS 8	909521  	PCS 13	980131  Ø6x60 	PCS 44
	PCS		PCS		PCS		PCS		PCS		PCS
	PCS		PCS		PCS		PCS		PCS		PCS

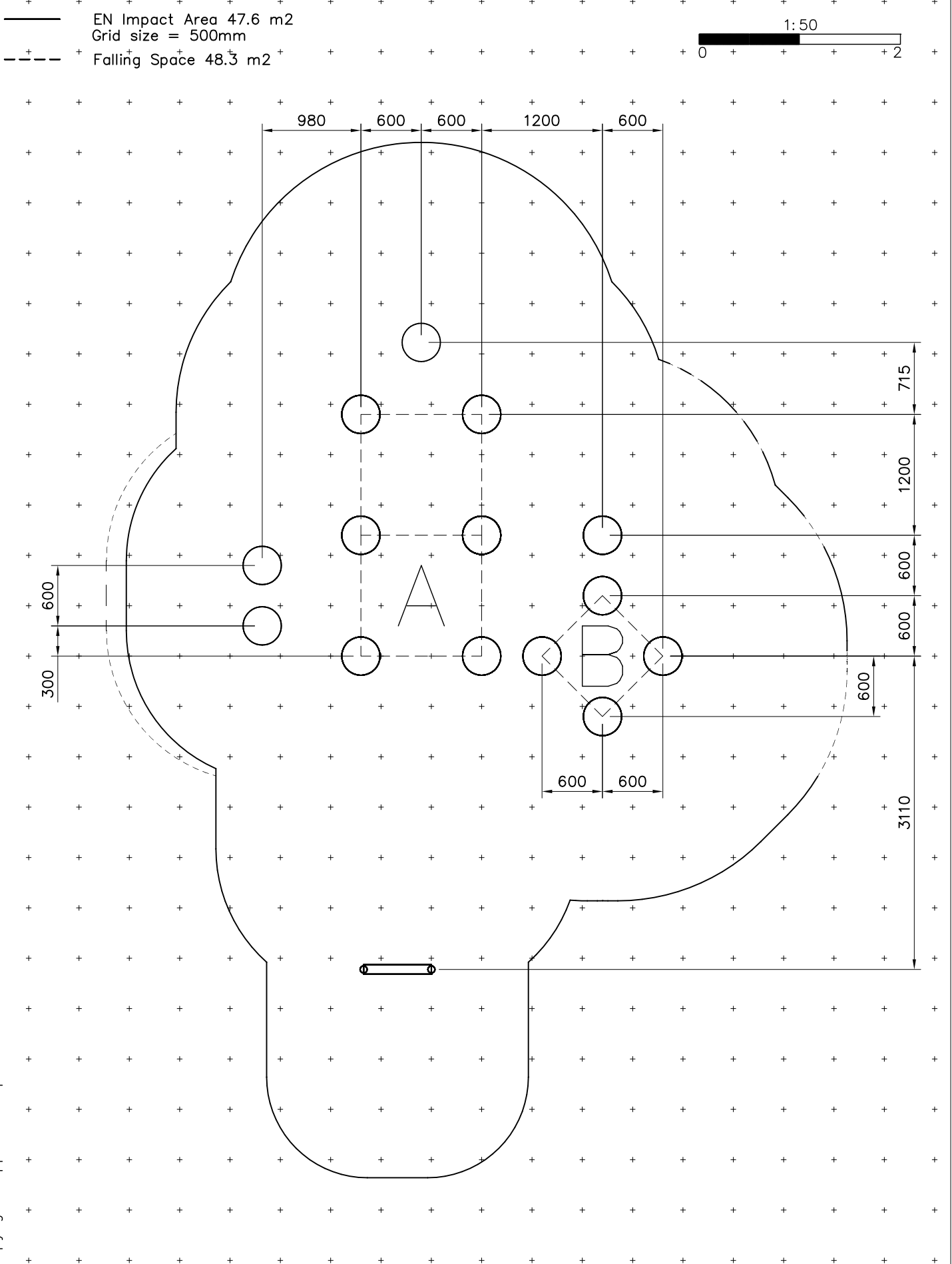

—— EN Impact Area 47.6 m²
 - - - - Falling Space 48.3 m²
 Max Falling Height 1970 mm

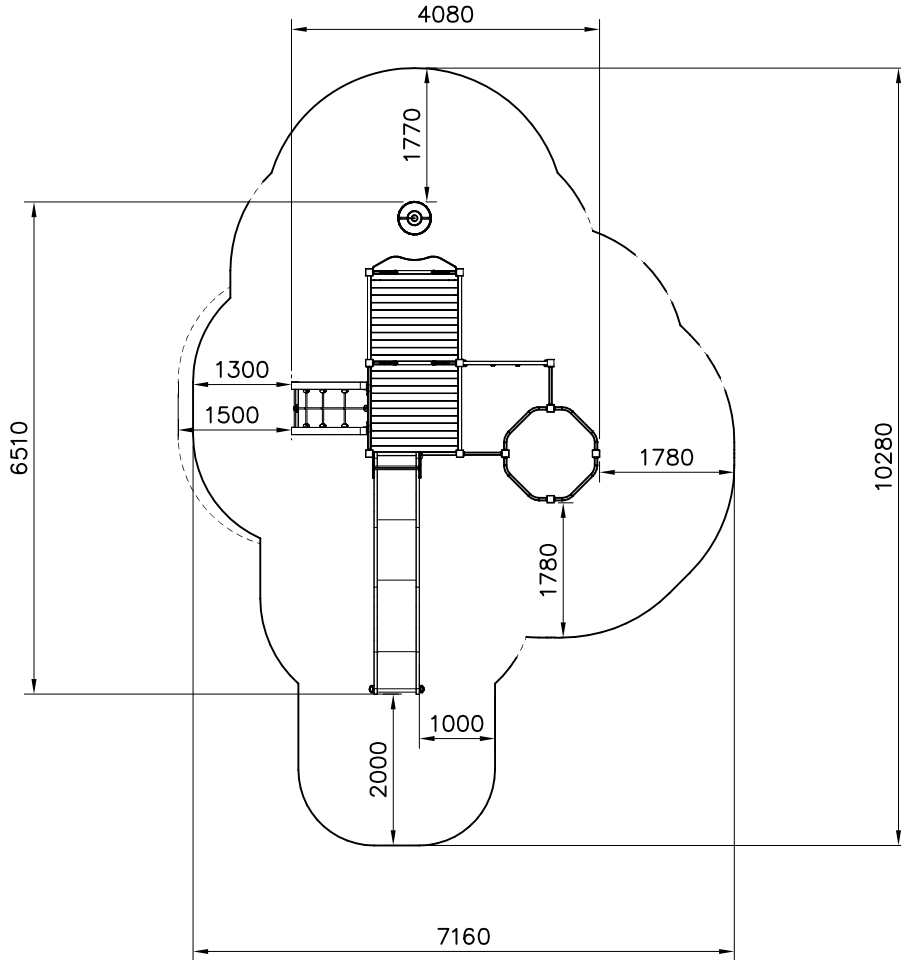
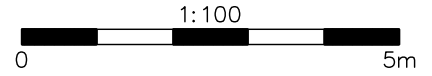

1:125

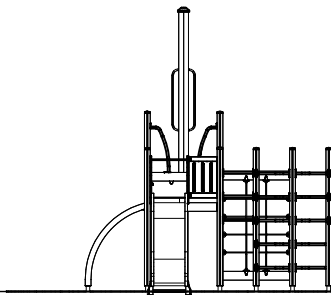

1:125

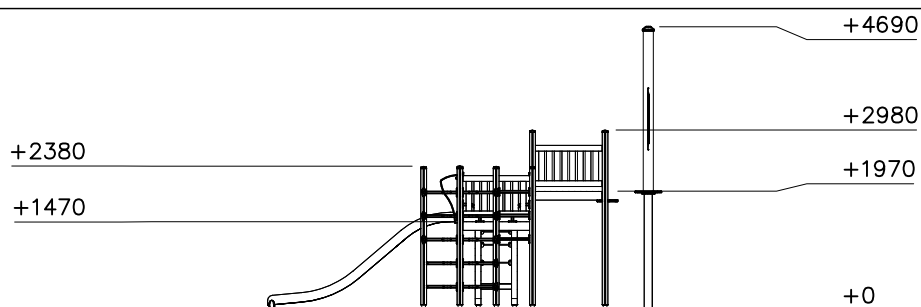

BARS
DET 1

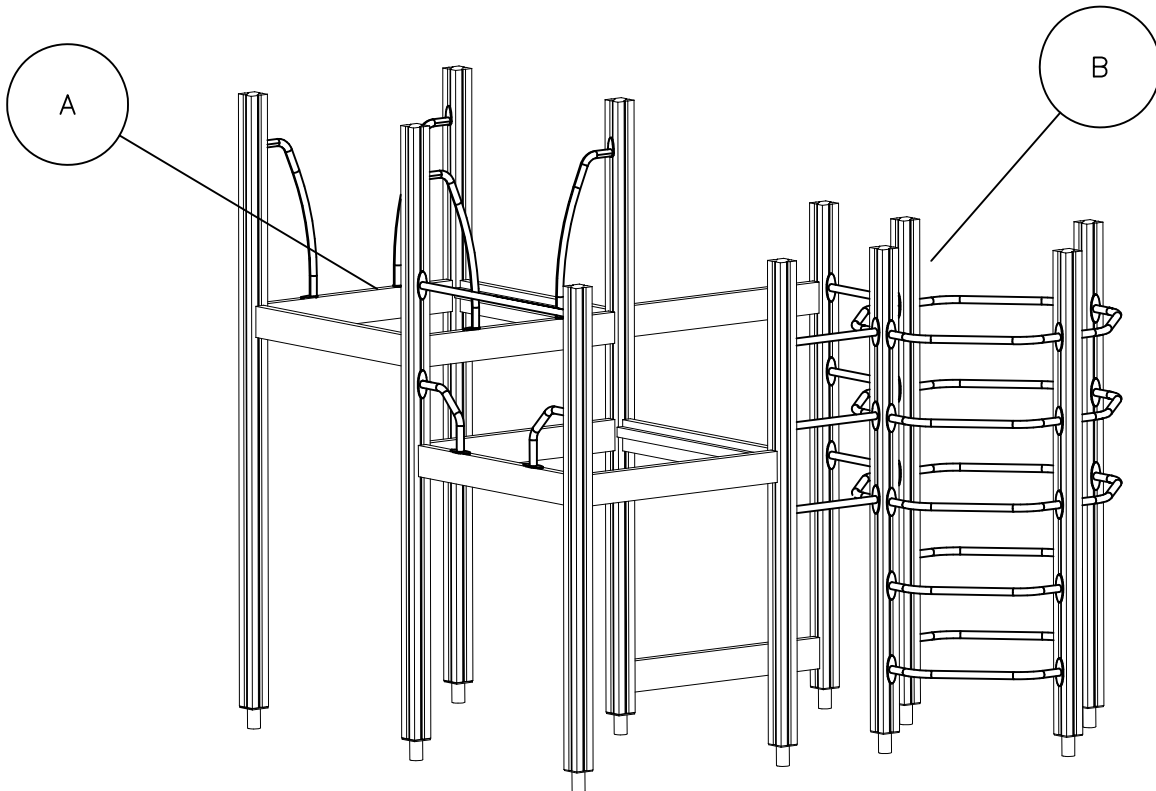
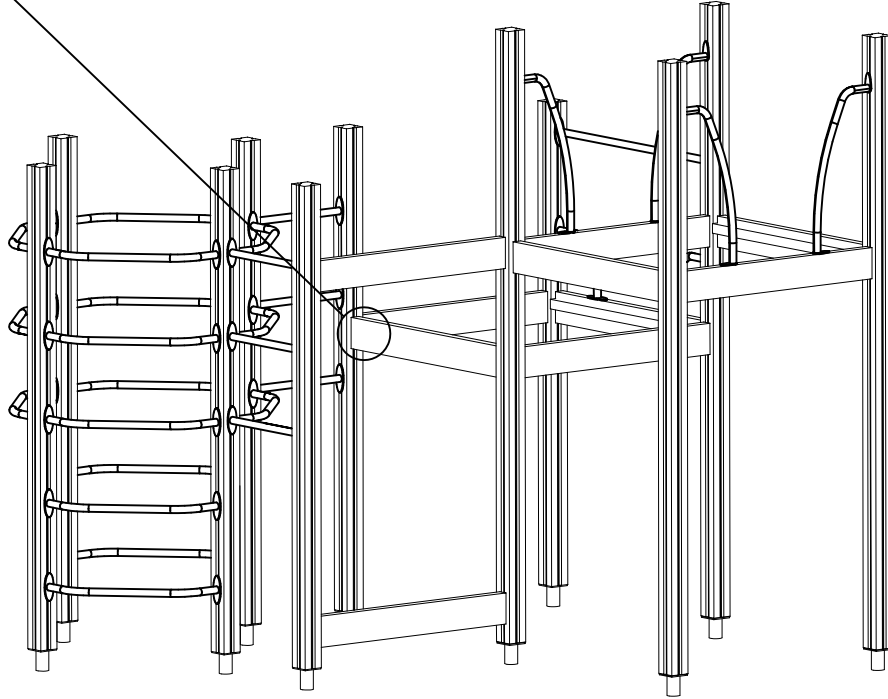

DATE: 8.4.2013

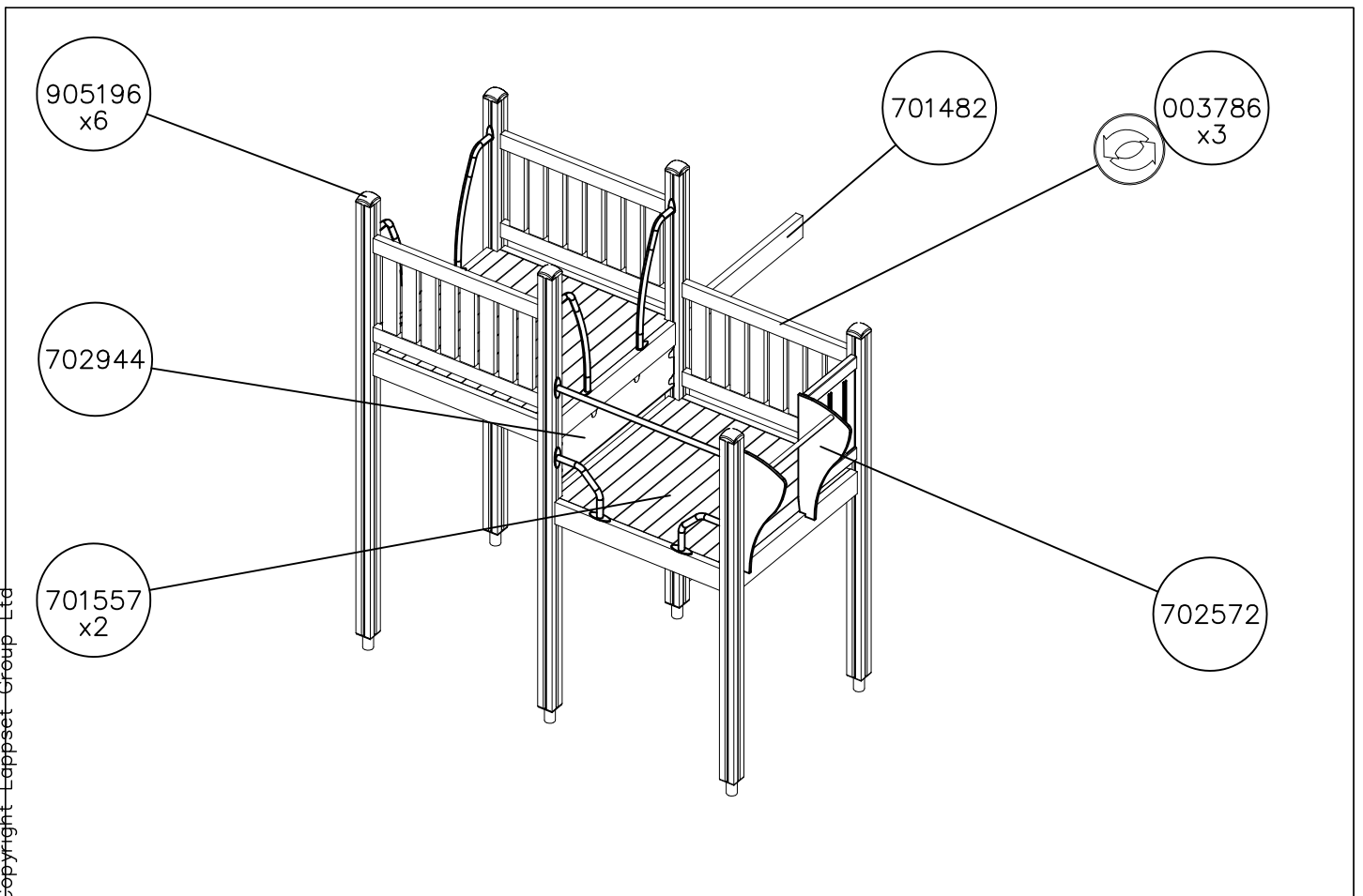
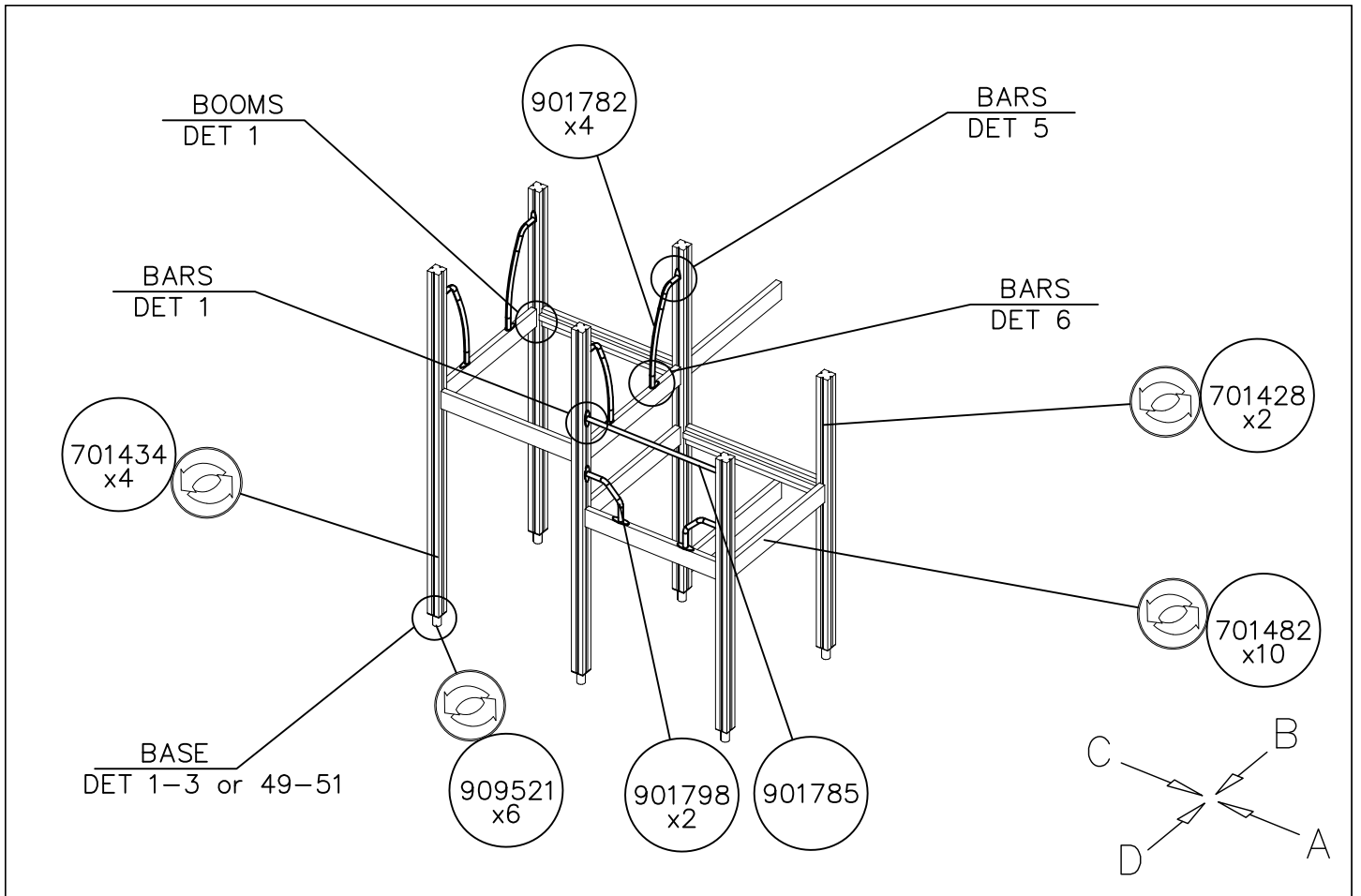

DATE: 8.4.2013

1:50

(A)

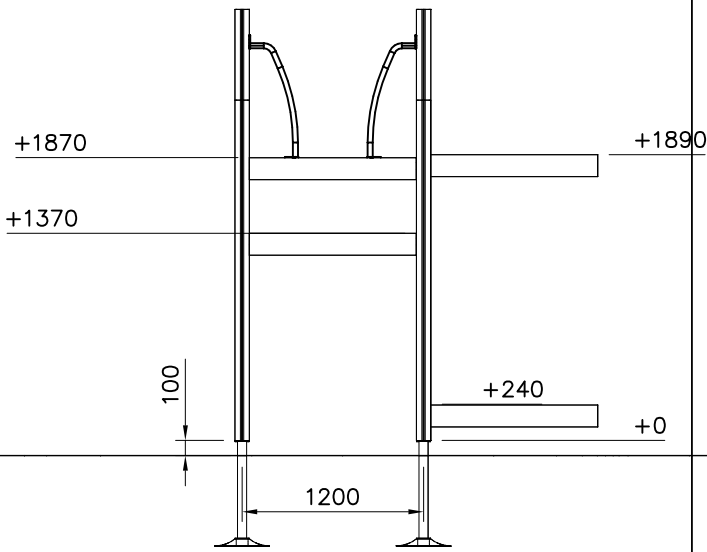

(B)

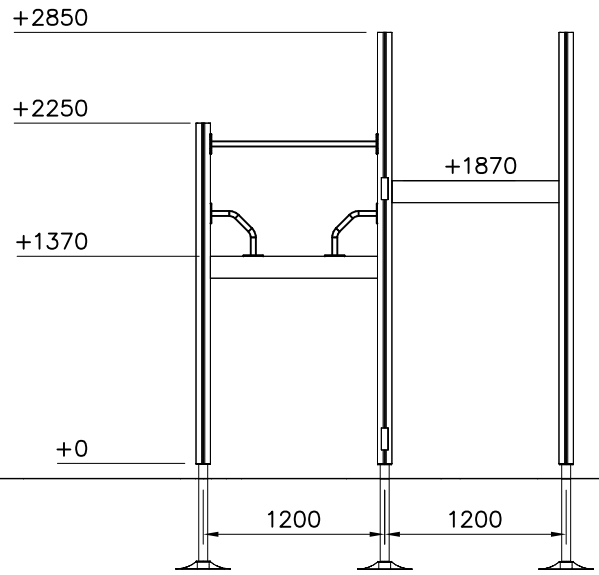

(C)

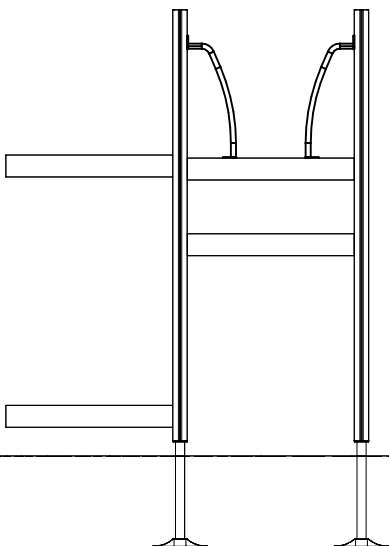

(D)

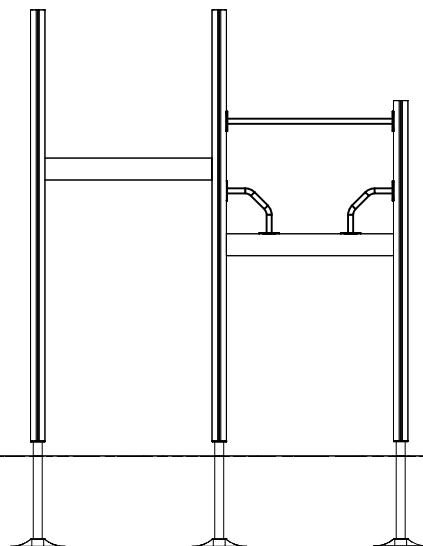

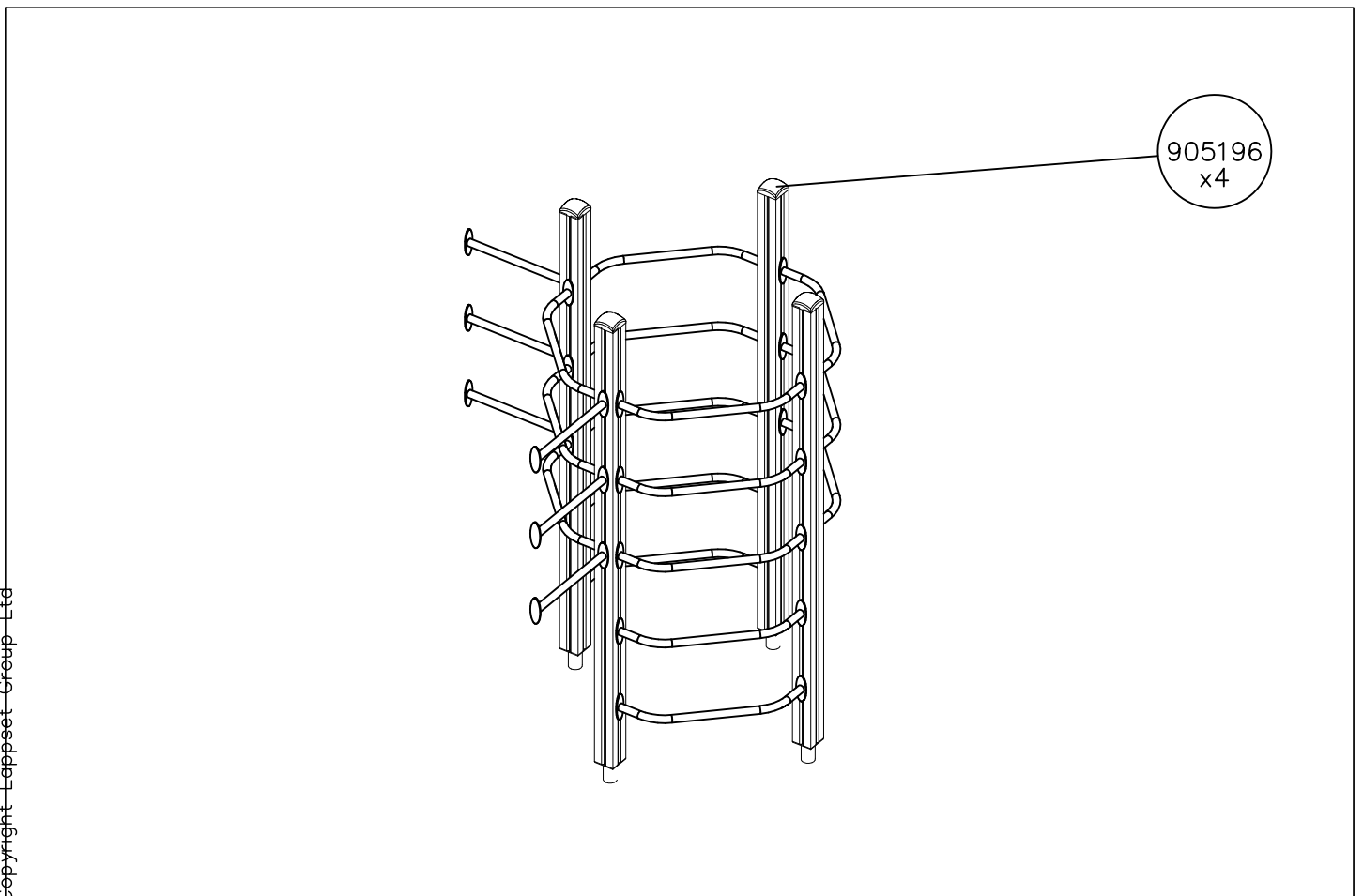
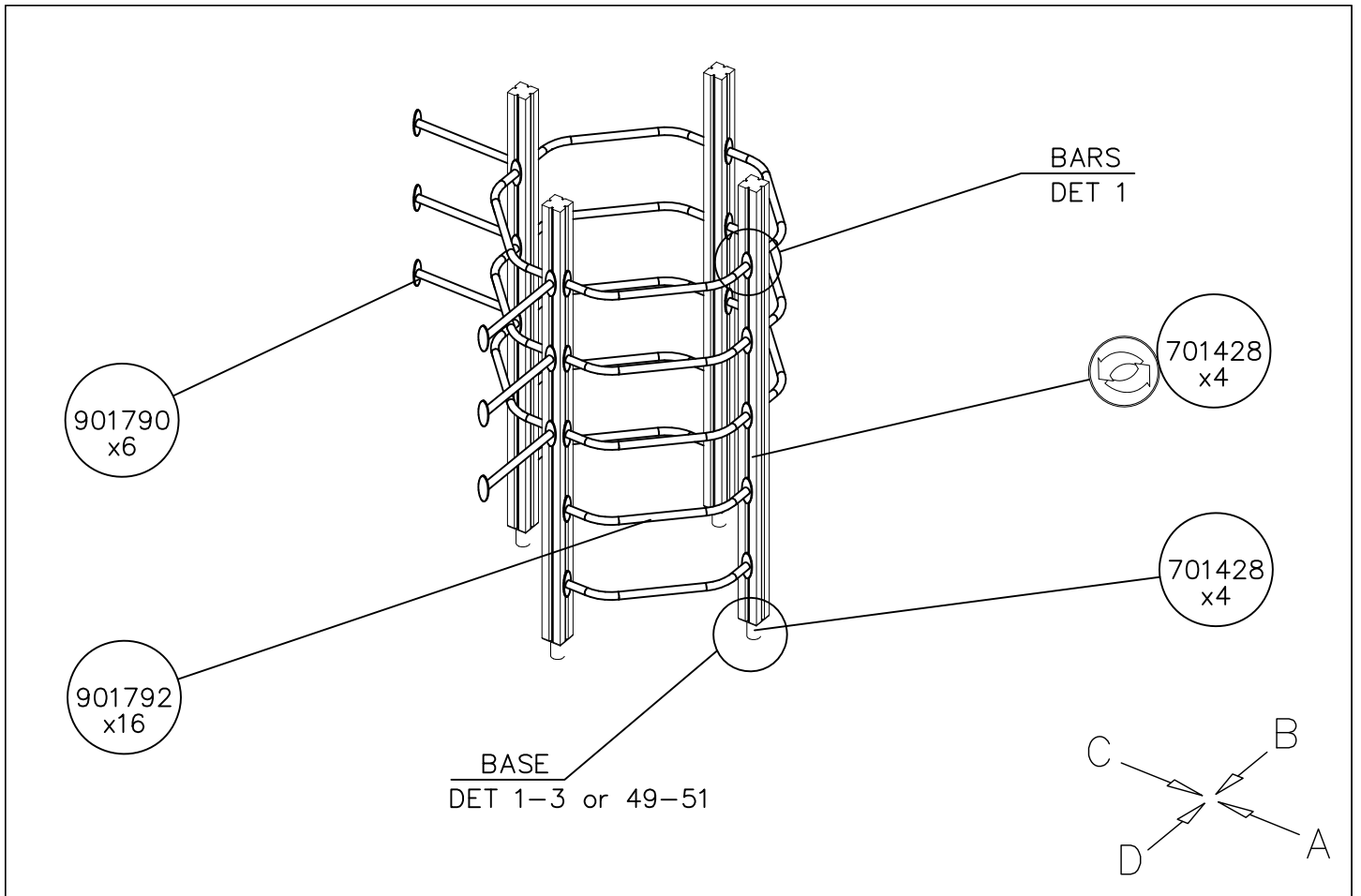

DATE: 8.4.2013

1:50

(A)

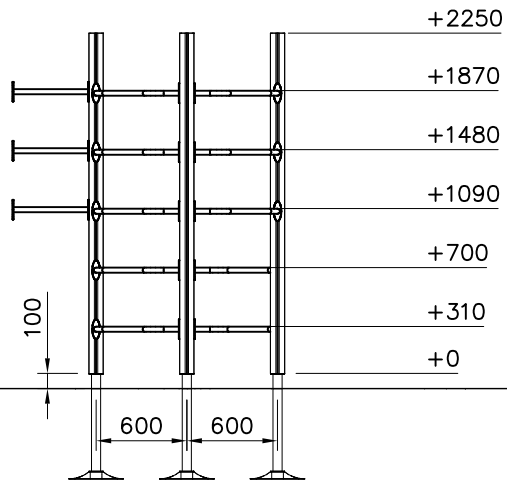

(B)

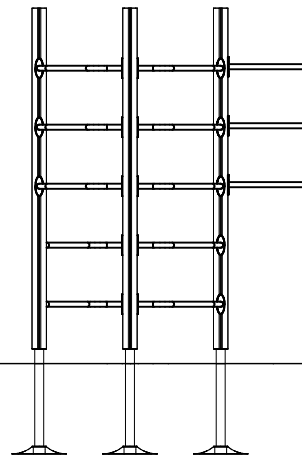

(C)

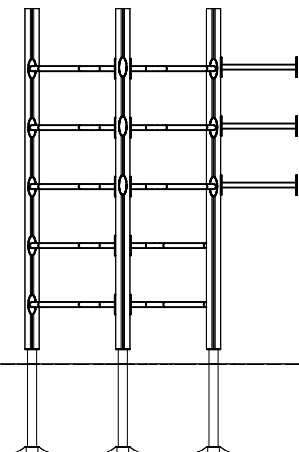

(D)

