

LAPPSET®

BASIC PRODUCTS



ASENNUSOHJE
MONTERINGSANSVISNING
INSTALLATION INSTRUCTION
AUFBAUANLEITUNG
NOTICE D'INSTALLATION

DATE: 15.2.2010

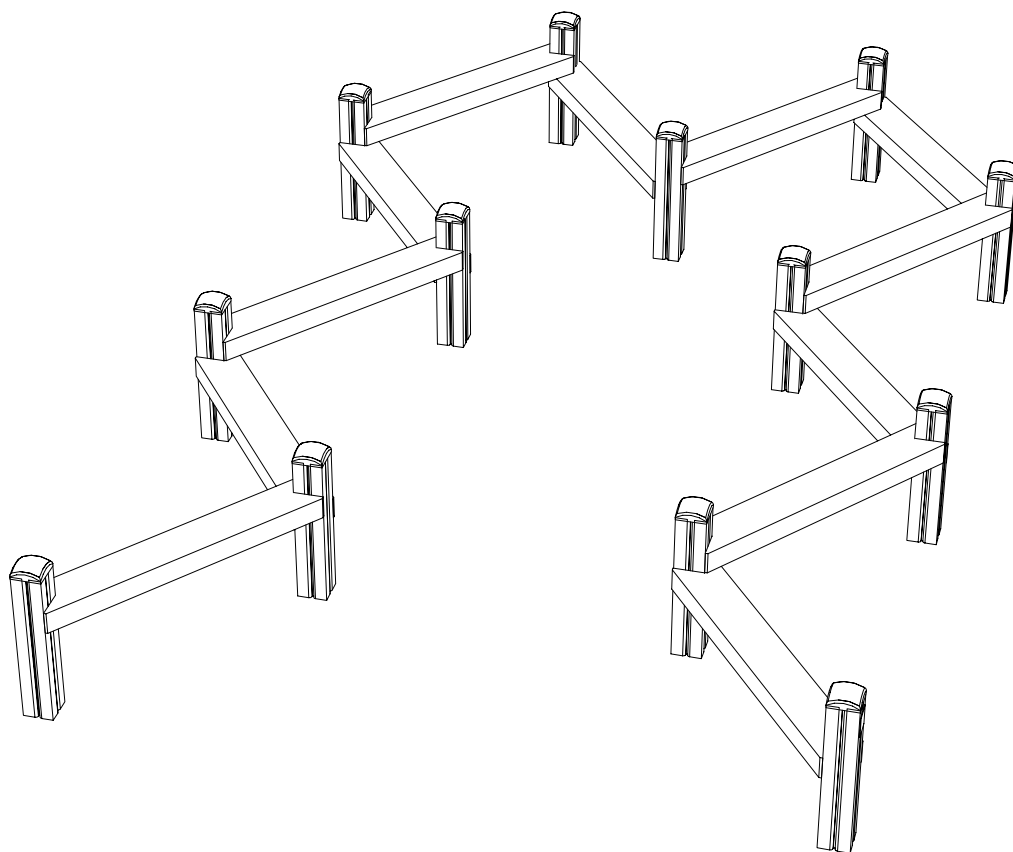
175020

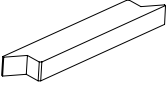

DATE: 15.2.2010

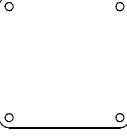
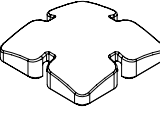
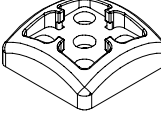
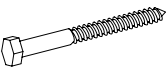
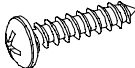
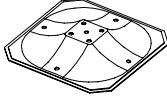
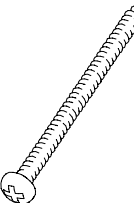
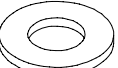
| | | | | | | | | | | | | | | | | | | | | | |
|--------|-----------|--|--------|-----------|---|---|---------|----------|---|---|----------|---|---|--------|-----------|---|---|---------|-----------|---|------|
| 008971 | PCS 12 |  | 703324 | PCS 13 |  | L 1050 | 702286 | PCS 1 |  | 902487 | PCS 1 |  | 65x65 | 905138 | PCS 13 |  | GRAY | 905196 | PCS 13 |  | GRAY |
| 909238 | PCS 48 |  | 8x90 | 909506 | PCS 4 |  | Ø3.5x13 | 909519 | PCS 13 |  | 980131 | PCS 52 |  | Ø6x60 | 980151 | PCS 48 |  | Ø16/8.4 | | | |
| | PCS | | | PCS | | | | PCS | | PCS | | | PCS | | PCS | | | | PCS | | |
| | PCS | | | PCS | | | | PCS | | PCS | | | PCS | | PCS | | | | PCS | | |
| | PCS | | | PCS | | | | PCS | | PCS | | | PCS | | PCS | | | | PCS | | |
| | PCS | | | PCS | | | | PCS | | PCS | | | PCS | | PCS | | | | PCS | | |

EN Impact Area 37 m²
Grid size = 500 mm.

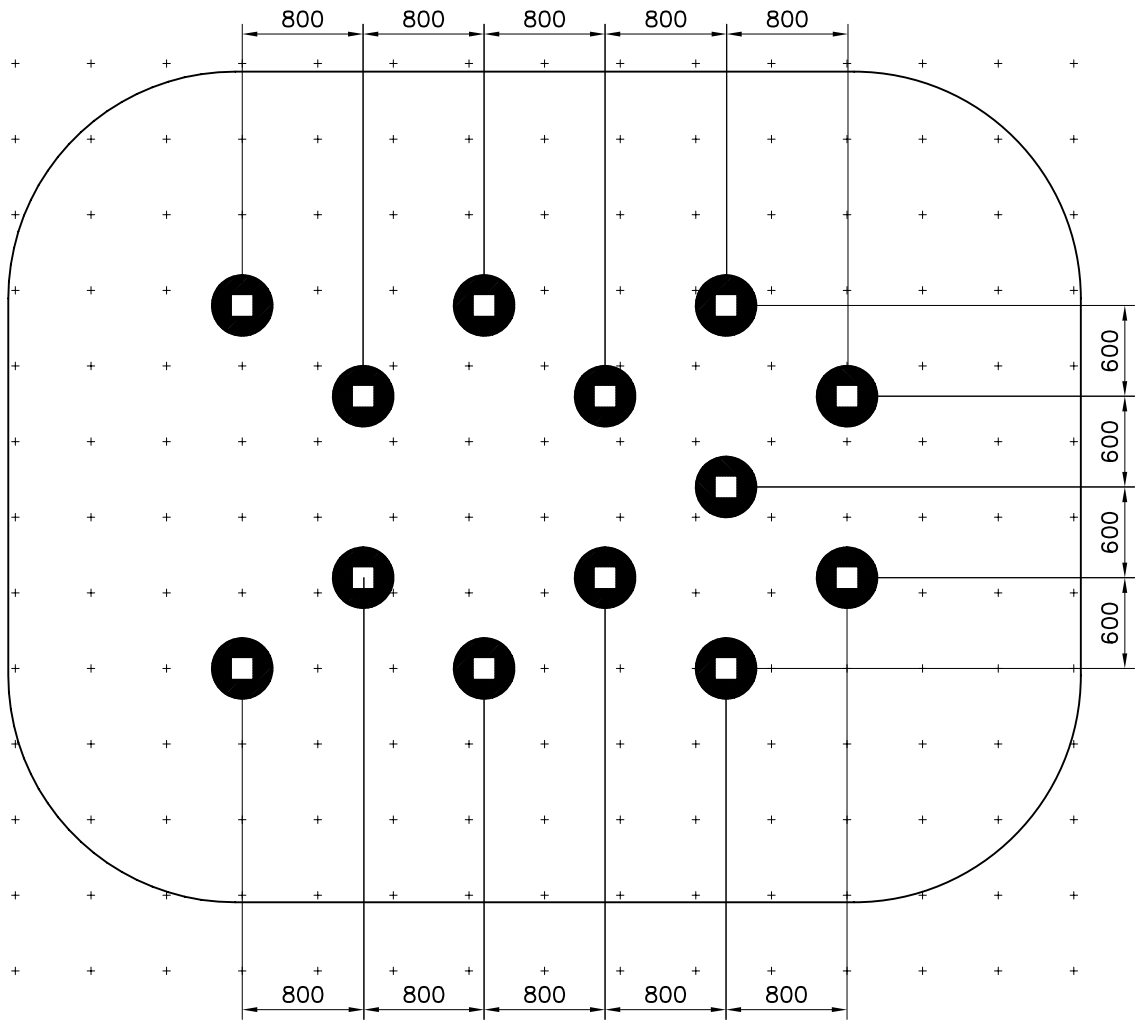
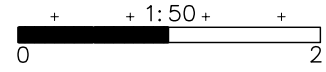

EN Impact Area 37 m²
 Max falling height 390 mm.

1:50

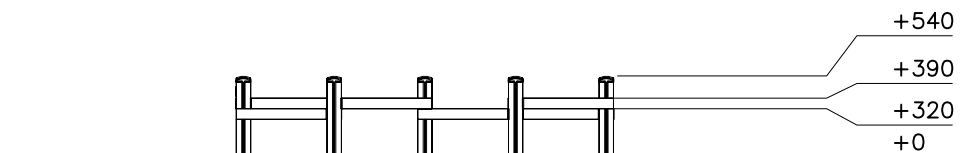
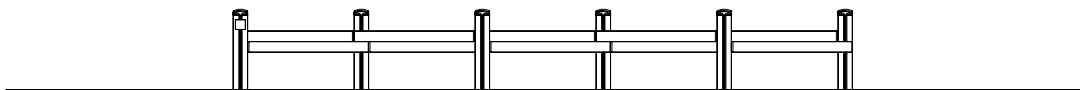
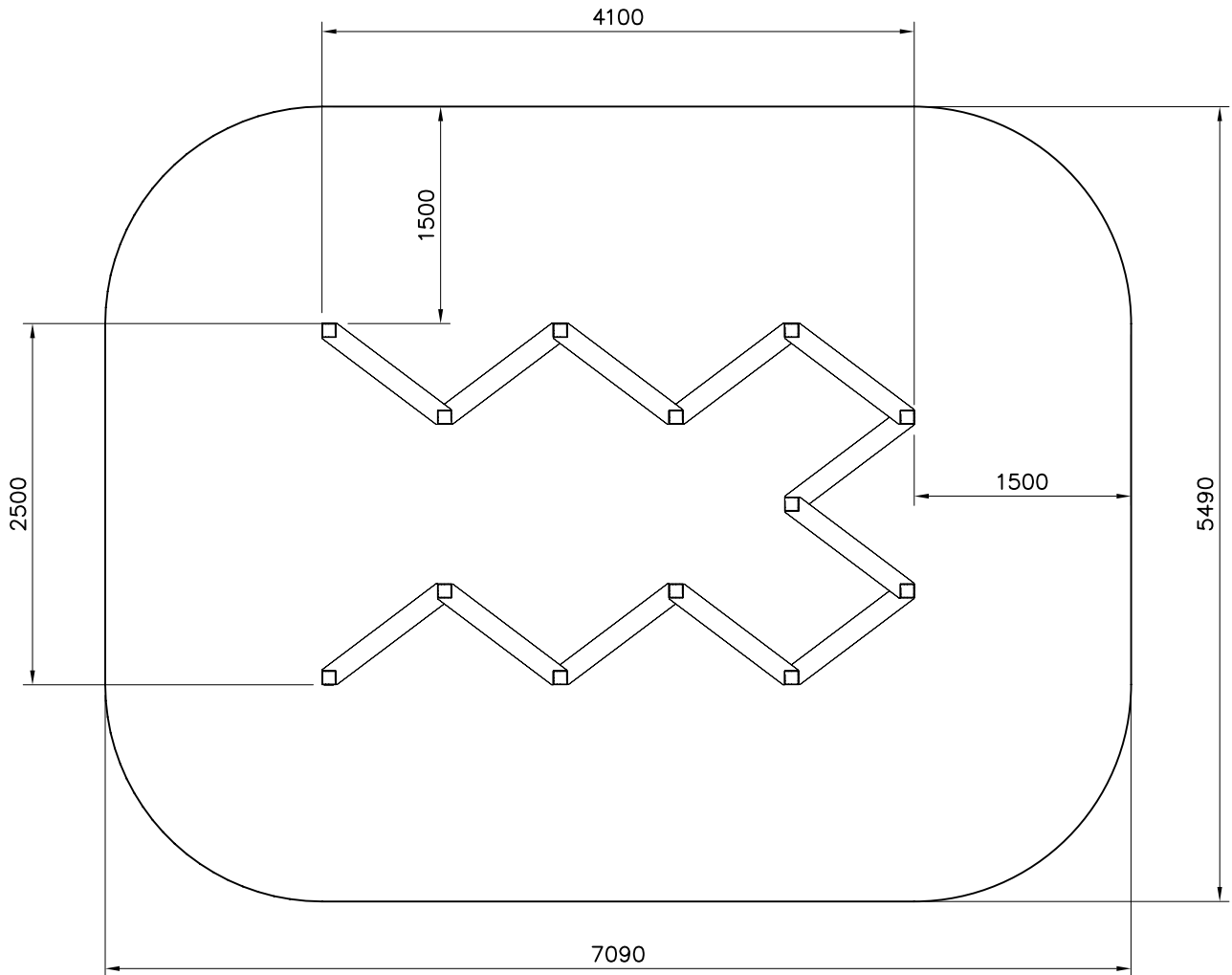

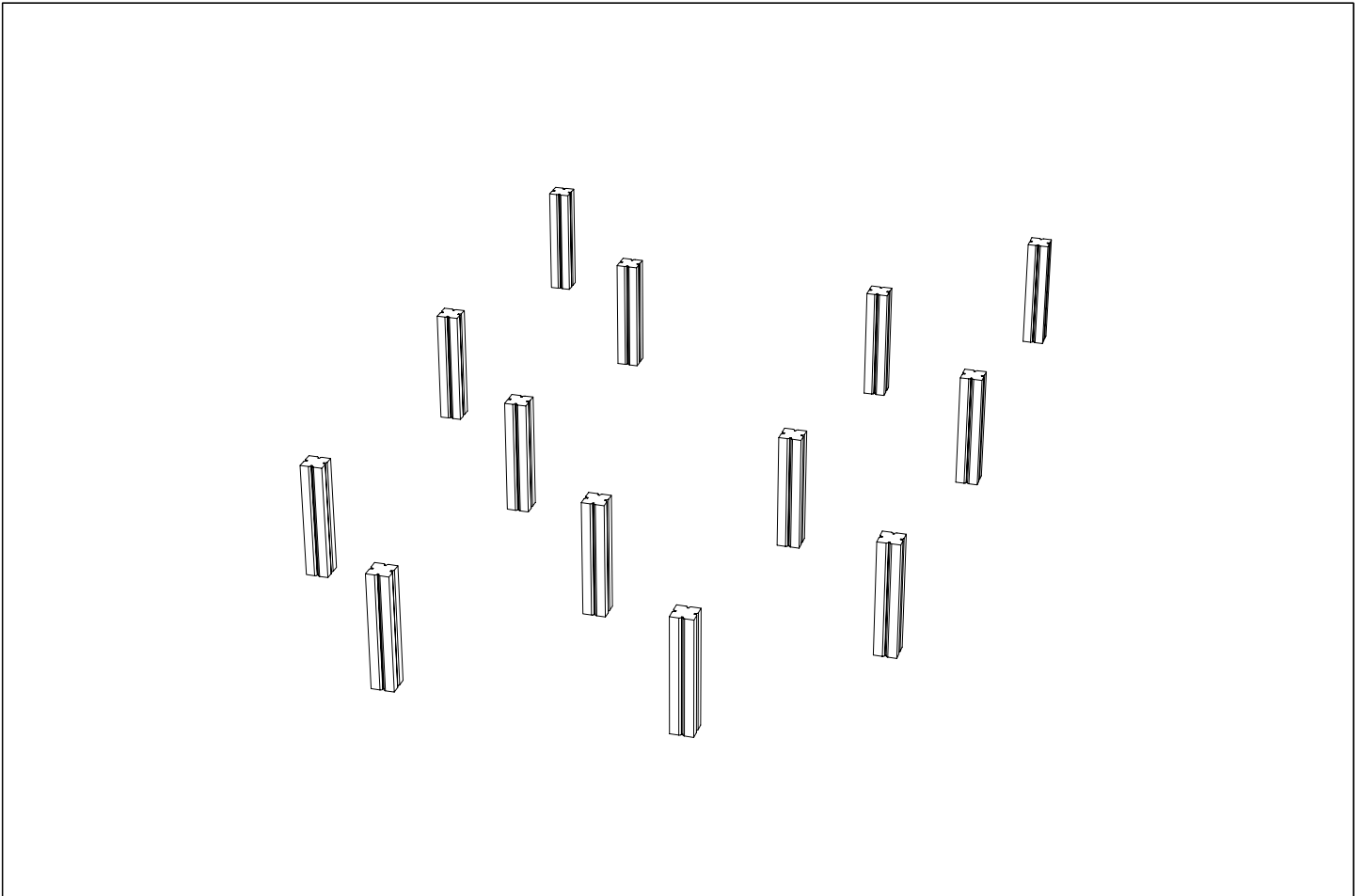
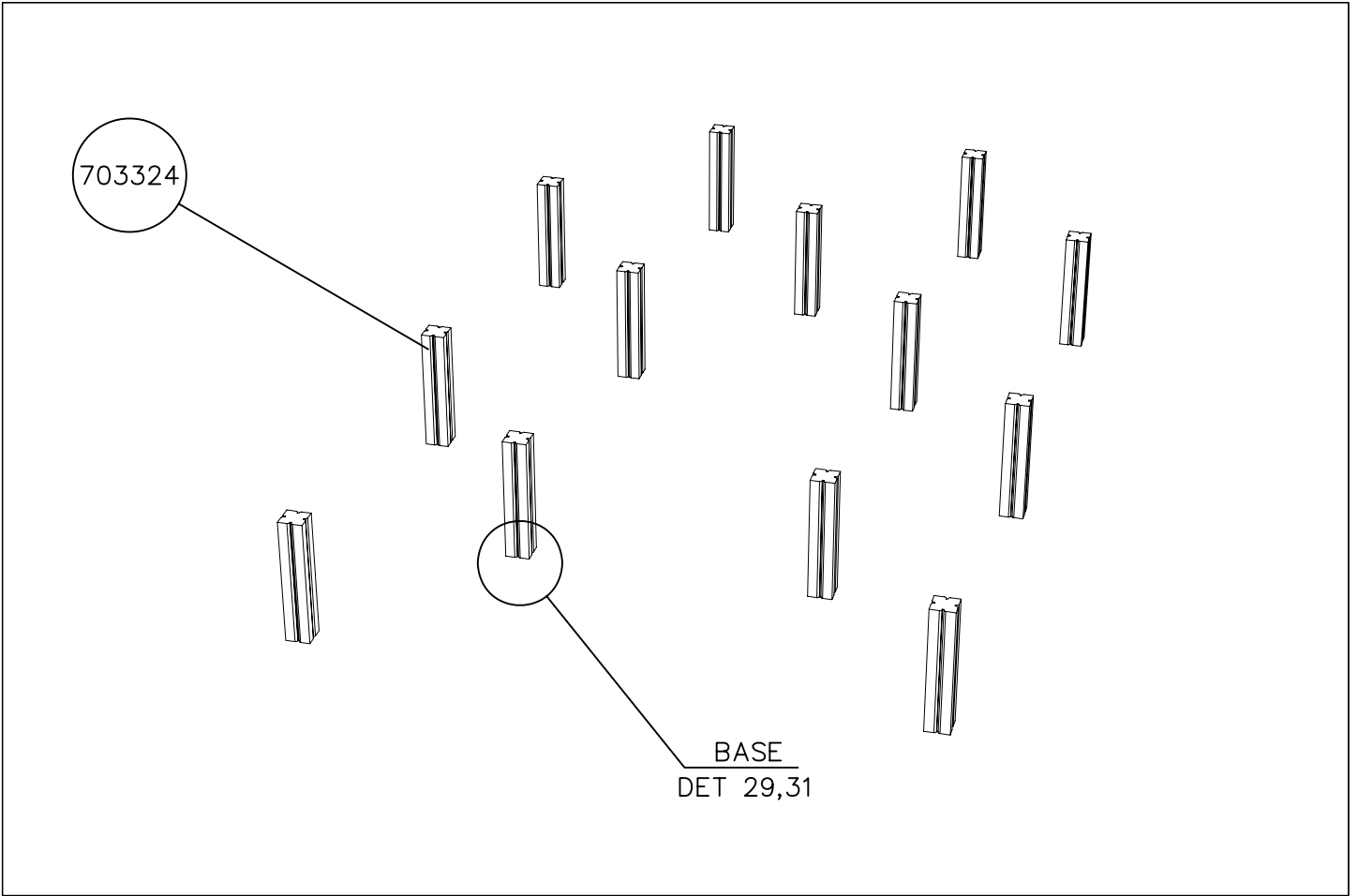

DET 1

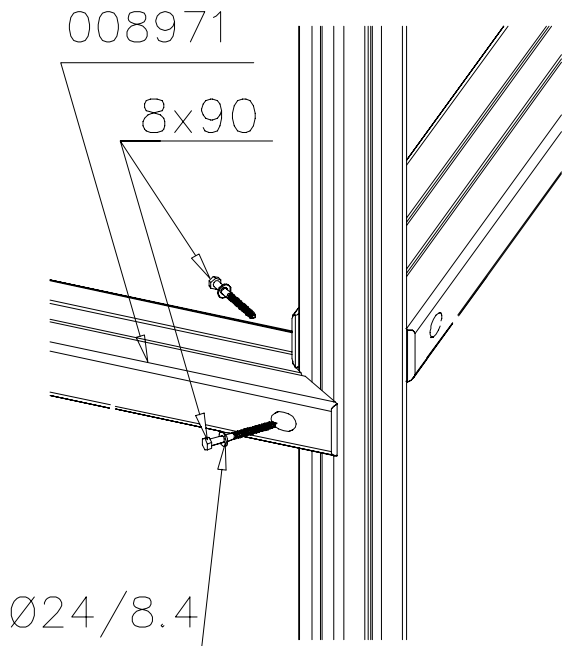

DET 2

